

A LUMINAIRE THAT BRINGS THE MAGIC OF A **BLUE-SKY** INDOORS

PROJECT: \_\_\_\_\_

FIXTURE TYPE: \_\_\_\_\_



**SkyView™ Tile** by BIOS Lighting is a revolution in healthy blue-sky lighting, designed to support mood, focus, alertness and circadian rhythm during daytime or evening hours.

**It's the only luminaire on the market that achieves ALL of the following:**

- Proven to boost Mood, Focus and Alertness
- Meets the Daytime Blue Sky Criteria of m-EDI > 250 vertical lux as per RP-46-25 & WELL
- Low Glare, UGR < 19
- Uses simple controls, no commissioning

**SkyView™ Day Mode Helps Boost**



MOOD



FOCUS



ALERTNESS

**ORDERING GUIDE**

Example: SVT-2x2-4000-D2E-DALI-MVOLT-ST-BLK

SVT – 2x2 – – – – –

Fixture Type	Size	Lumen Output	Light Mode
SVT: SkyView™ Tile	2x2	3000 lm	D2E: 2-Channel Day/Night
		4000 lm	
		5000 lm	

Dimming	Input Voltage	Shipping	Finish
<b>0-10V:</b> 0-10V	<b>MVOLT:</b> 120-277	<b>ST:</b> Standard Lead Time	____ : White
<b>DALI:</b> DT2 DALI8			<b>BLK:</b> Black



## DESIGN OPTIONS

### Daytime Melanopic Ratio

M-DER 1.1  
M-EER or MP Ratio 1.2

### Lumen Output

3000 lumens  
4000 lumens  
5000 lumens

### Finishes



White



Black



Custom

### Mounting

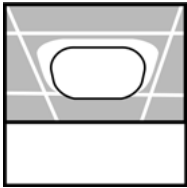

Grid Mount

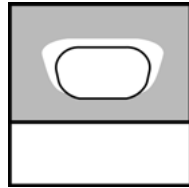

Recessed Mount

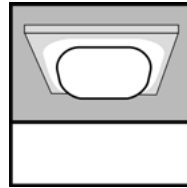

Surface Mount

### Color Rendering

>91 CRI  
>82 R9

### TM-30

Rg 99  
Rf 90

### Sustainability and Wellness

WELL • RP-46-25 • Declare Red List Approved

## LIGHTING SYSTEM FEATURES

- Patented Blue Sky Gradient™ Technology, providing the health benefits of a blue-sky day indoors
- Volumetric light distribution maintains uniformity ratios of <2:1
- Day Mode proven to boost mood, focus and alertness
- Declare Label - Red List Approved
- 0.4 W/ft<sup>2</sup> on a 10ft x 10ft grid
- L90 at 60000 hours

## COLOR

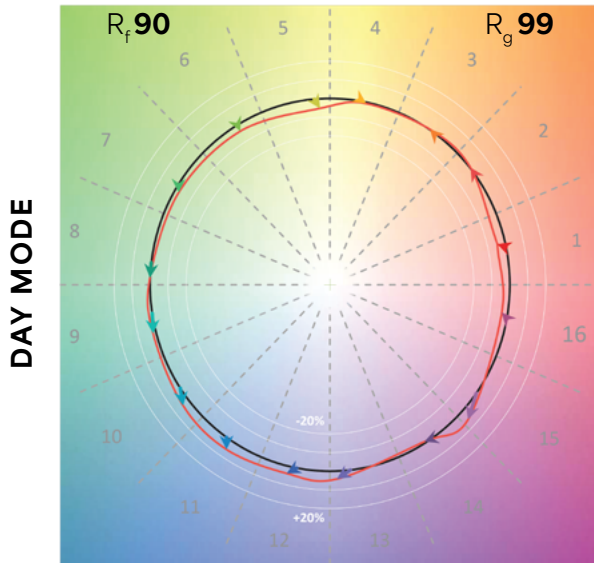

CRI	≥ 91
R9	≥ 82
TM-30	
Rg	99
Rf	90
Delivered CCT*	5300K

\*CCT range is **15000K** to **4000K** with an average of **5300K**.

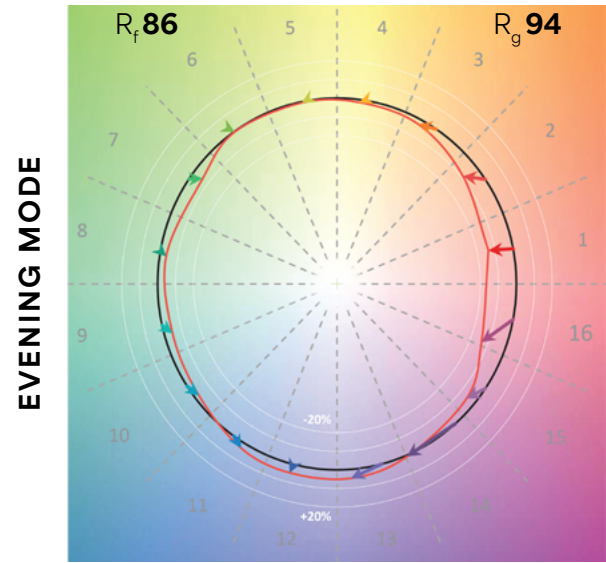

CRI	≥ 82
TM-30	
Rg	94
Rf	86
CCT	2300K

## LIGHT DISTRIBUTIONS

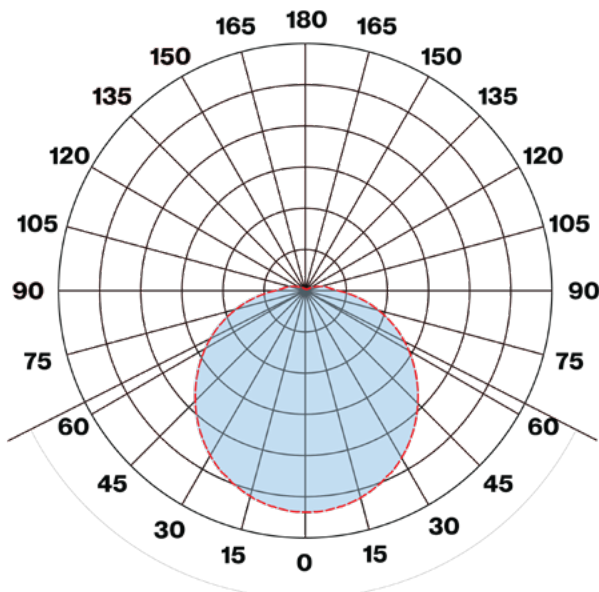

**DAY MODE**

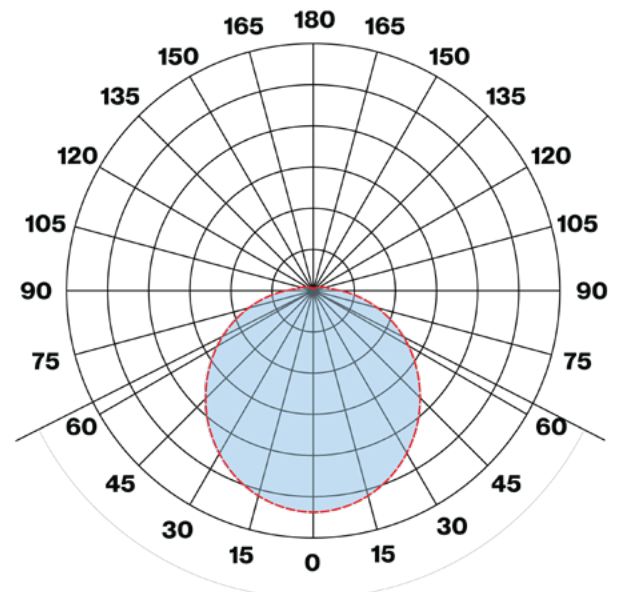

**EVENING MODE**

## SPECTRAL POWER DISTRIBUTION CHARTS

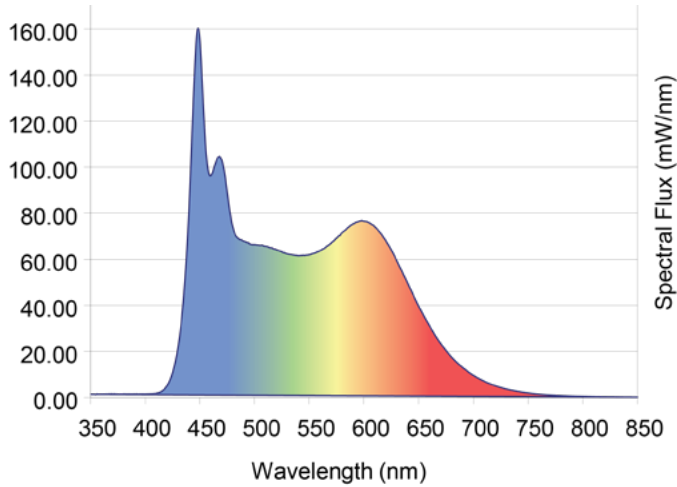

**DAY MODE**

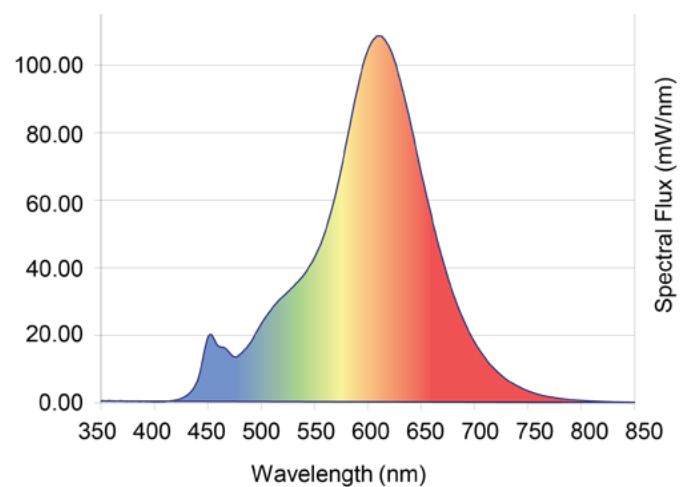

**EVENING MODE**

## PERFORMANCE CHARTS

### DAY MODE White (WHT) Finish

Type	Lumens	Wattage	MP Ratio	MDER	Efficacy
3000 WHT	3790	31W	1.2	1.1	118 lm/W
4000 WHT	4858	42W	1.2	1.1	114 lm/W
5000 WHT	6095	55W	1.2	1.1	111 lm/W

### DAY MODE Black (BLK) Finish

Type	Lumens	Wattage	MP Ratio	MDER	Efficacy
3000 BLK	3180	31W	1.1	1.0	102 lm/W
4000 BLK	4212	42W	1.1	1.0	98 lm/W
5000 BLK	5084	55W	1.1	1.0	93 lm/W

### EVENING MODE White (WHT) Finish

Type	Lumens	Wattage	MP Ratio	MDER	Efficacy
3000 WHT	3401	36W	0.38	0.33	94 lm/W
4000 WHT	4244	46W	0.38	0.33	92 lm/W
5000 WHT	5081	57W	0.38	0.33	89 lm/W

### EVENING MODE Black (BLK) Finish

Type	Lumens	Wattage	MP Ratio	MDER	Efficacy
3000 BLK	2856	36W	0.35	0.30	80 lm/W
4000 BLK	3565	46W	0.35	0.30	78 lm/W
5000 BLK	4267	57W	0.35	0.30	75 lm/W

## DIMENSIONS

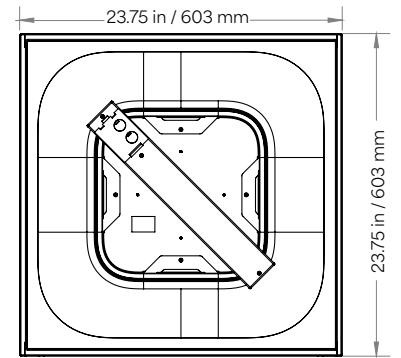
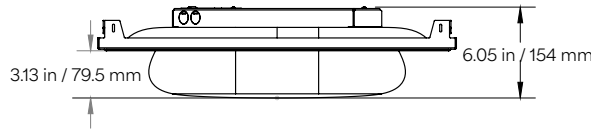
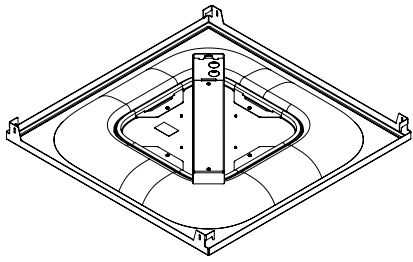

## TYPICAL LIGHTING LAYOUT

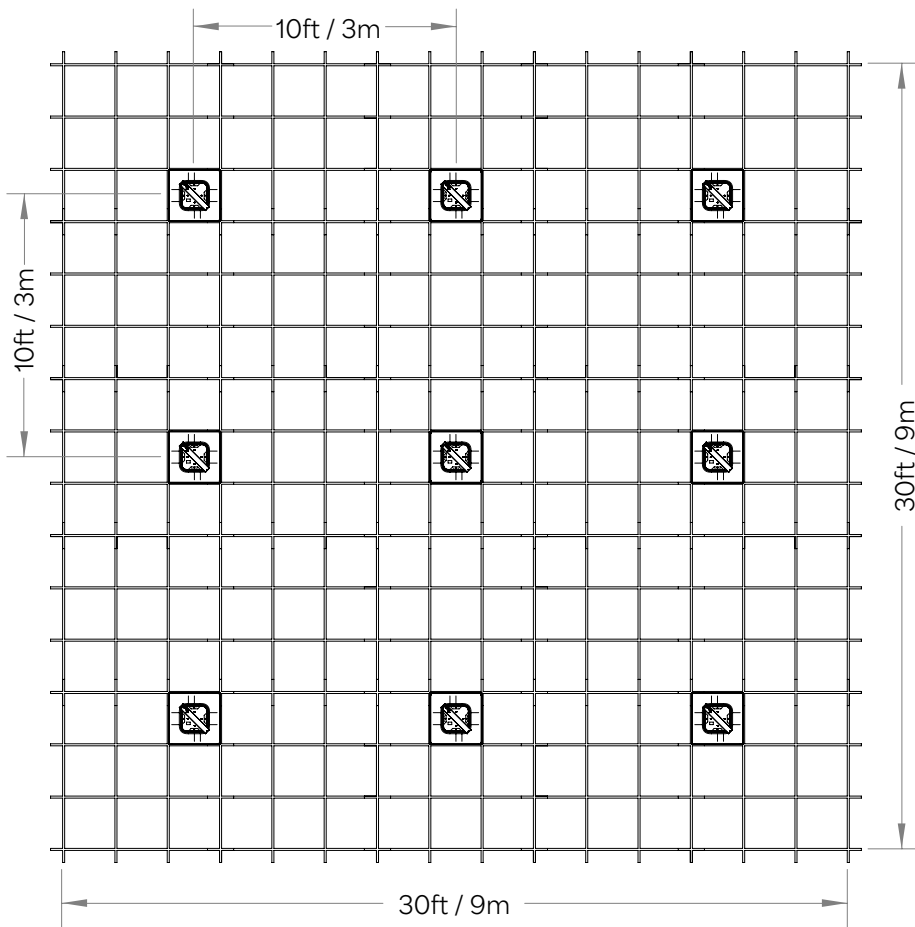

Example placement of a 4000 lm fixture layout in a 30ft x 30ft / 9.14m x 9.14m room with a 10ft / 3.05m ceiling height, achieving 35 FC / 300 lux task plane luminance and 250 melanopic equivalent daylight illuminance (m-EDI).

## LIFETIME EXPECTANCY

LM-80 Data	
L70	> 60000 hours
L80	> 60000 hours
L90	> 60000 hours

## UGR

Lumen Package	UGR
3000	16 WHT
3000	15 BLK
4000	17 WHT
4000	16 BLK
5000	18 WHT
5000	17 BLK

## SUGGESTED SPACING GRID

Grid Spacing	Lumen Output	Horizontal FC	Vertical m-EDI	Ceiling Height	LPD
10ft x 10ft	4000	35	250	8.5ft - 10ft	0.40 W/ft <sup>2</sup>
8ft x 8ft	3000	35	250	8ft	0.44 W/ft <sup>2</sup>
12ft x 12ft	5000	35	250	10ft - 11ft	0.43 W/ft <sup>2</sup>



## WIRING DIAGRAMS

### 0-10V

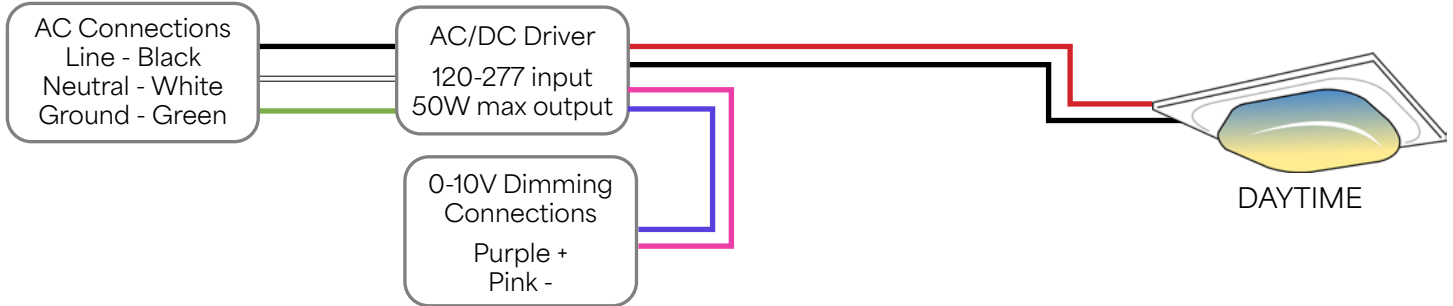

### DALI 2 DT8

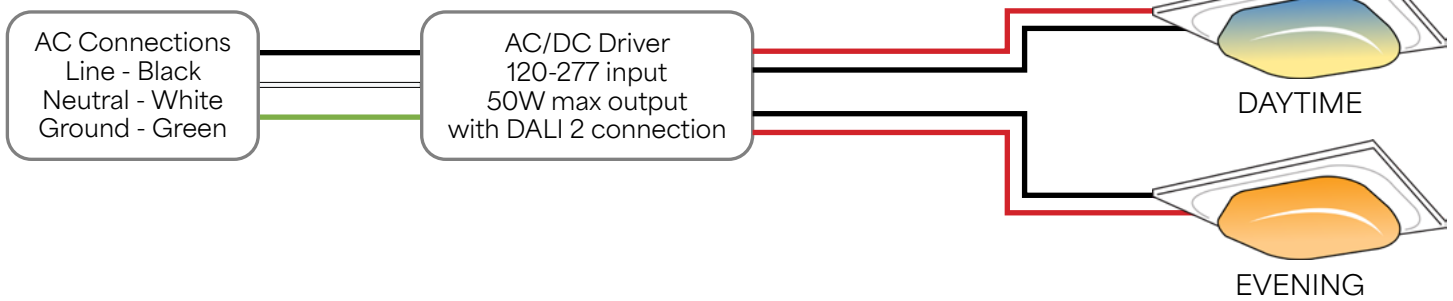

## TECHNICAL SPECIFICATIONS

### CONSTRUCTION

- Formed 24 ga. steel housing
- Universal T-bar clips, seismic restraint tabs/tie-offs

### OPTICAL

- Patented SkyView™ Blue Sky Gradient™ Technology light engine
- Precision molded high transmittance LLDPE plastic diffuser that is recyclable
- Long-life LED system designed for typical TM21 lumen maintenance  $\geq$  L90 @ 60000 hours
- Available in 3000, 4000 and 5000 lumen packages with CRI  $\geq$  90 and R9  $\geq$  80
- CCT range is 15000K to 4000K with a delivered CCT of 5300K

### ELECTRICAL

- Driver Lifetime: 50000 hours
- Power Factor > 0.95
- Total Harmonic Distortion < 20%
- Dim level: Standard Day/Evening 100-0.01%
- Surge Protection: Meets ANSI C82.11 spec and ANSI/IEEE C62.41
- Inrush Current: Meets NEMA 410

### CONTROLS

- SkyView™ fixtures use standard building control protocols, like 0-10V and DALI 2. Because SkyView™ products do not dynamically change CCT throughout the day like many tunable white or circadian fixtures on the market, simple room-level controls can be used. Wall box dimmers, distributed solutions, like power packs or even panel-based solutions can all control SkyView™ products.
- SkyView™ Tile from BIOS Lighting supports integrated occupancy sensing and daylight harvesting controls to improve energy performances without compromising circadian lighting outcomes.

### DALI DRIVER

- DALI 2 DT8 means that one DALI address controls intensity and day/evening

### ENVIRONMENT

- Designed for use in dry or damp indoor locations with ambient temperatures of 0-30° C or 32-86° F
- IP22 Rating
- Not suitable for natatorium environments

### WEIGHT

- Maximum 10 lbs (4.54 kg) with standard driver

### WARRANTY

- 5-year limited warranty on all components and workmanship

### INDEPENDENT TESTING

- IESNA LM79
- IESNA LM80 (LED @ 10000 hours)

### APPROVALS

- UL Listed (USA + Canada)
- RoHS Certificate of Conformity
- Declare Red List Approved