

A LUMINAIRE THAT BRINGS THE MAGIC OF A **BLUE-SKY** INDOORS

PROJECT: _____

FIXTURE TYPE: _____



SkyView™ Tile by BIOS Lighting is a revolution in healthy blue-sky lighting, designed to support mood, focus, alertness and circadian rhythm during daytime or evening hours.

It's the only luminaire on the market that achieves ALL of the following:

- Proven to boost Mood, Focus and Alertness
- Meets the Daytime Blue Sky Criteria of m-EDI > 250 vertical lux as per RP-46-25 & WELL
- Low Glare, UGR < 19
- Uses simple controls, no commissioning

SkyView™ Day Mode Helps Boost



MOOD



FOCUS



ALERTNESS

ORDERING GUIDE

Example: SVT-2x2-4000-D2N-DALI-MVOLT-ST-BLK

SVT – 2x2 – – – – –

Fixture Type	Size	Lumen Output	Mode
SVT: SkyView™ Tile	2x2	3000 lm	DBN: BioDimmer™ Day/Night
		4000 lm	
		5000 lm	D2N: 2-Channel Day/Night

Dimming	Input Voltage	Shipping	Finish
SD: 0-10V	MVOLT: 120-277	ST: Standard Lead Time	____ : White
DALI: DT2 DALI8			BLK: Black



DESIGN OPTIONS

Daytime Melanopic Ratio

M-DER 1.1
M-EER or MP Ratio 1.2

Lumen Output

3000 lumens
4000 lumens
5000 lumens

Finishes



White



Black



Custom

Mounting

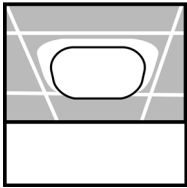

Grid Mount

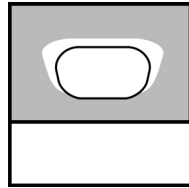

Recessed Mount

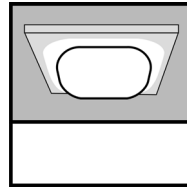

Surface Mount

Color Rendering

>91 CRI
>82 R9

TM-30

Rg 99
Rf 90

Sustainability and Wellness

WELL • RP-46-25 • Declare Red List Approved

LIGHTING SYSTEM FEATURES

- Patented Blue Sky Gradient™ Technology, providing the health benefits of a blue-sky day indoors
- Volumetric light distribution maintains uniformity ratios of <2:1
- Day Mode proven to boost mood, focus and alertness
- Declare Label - Red List Approved
- 0.4 W/ft² on a 10ft x 10ft grid
- L90 at 60000 hours

COLOR

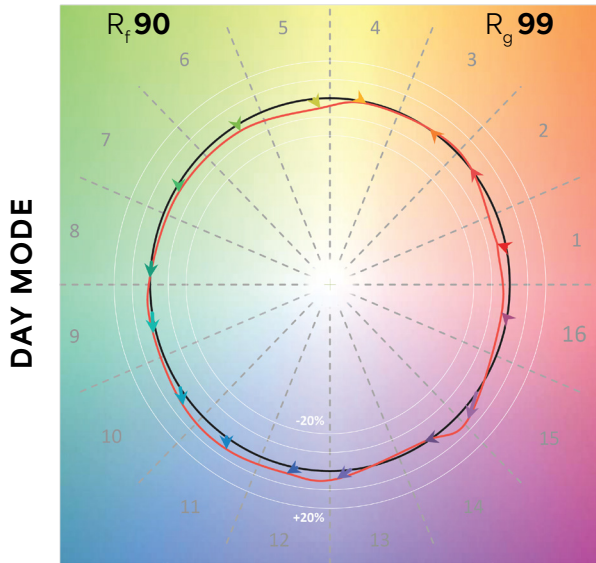

CRI	≥ 91
R9	≥ 82
TM-30	
Rg	99
Rf	90
Delivered CCT*	5300K

*CCT range is **15000K** to **4000K** with an average of **5300K**.

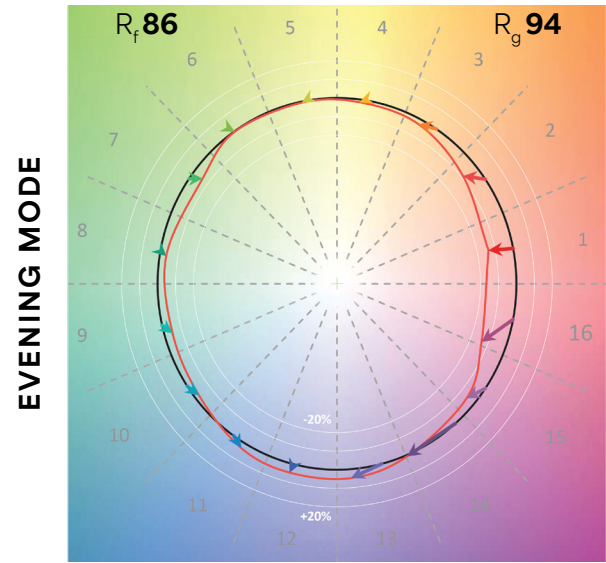

CRI	≥ 82
TM-30	
Rg	94
Rf	86
CCT	2300K

LIGHT DISTRIBUTIONS

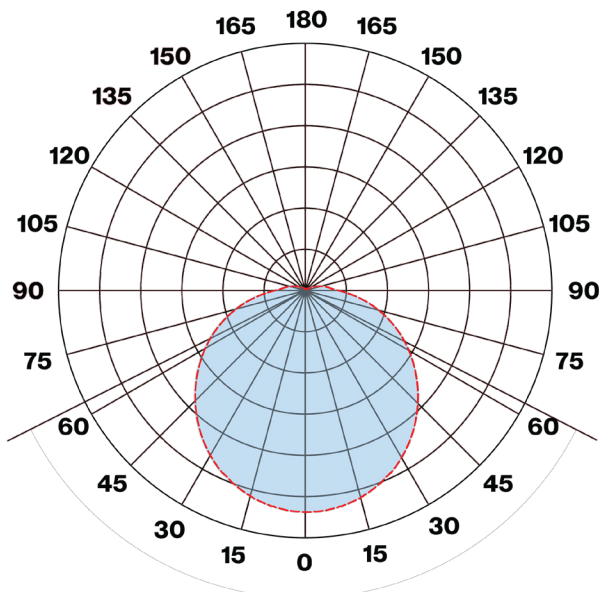

DAY MODE

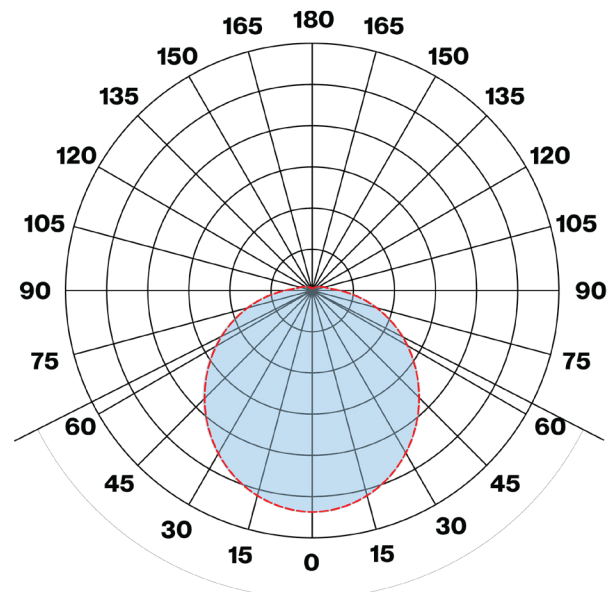

EVENING MODE

SPECTRAL POWER DISTRIBUTION CHARTS

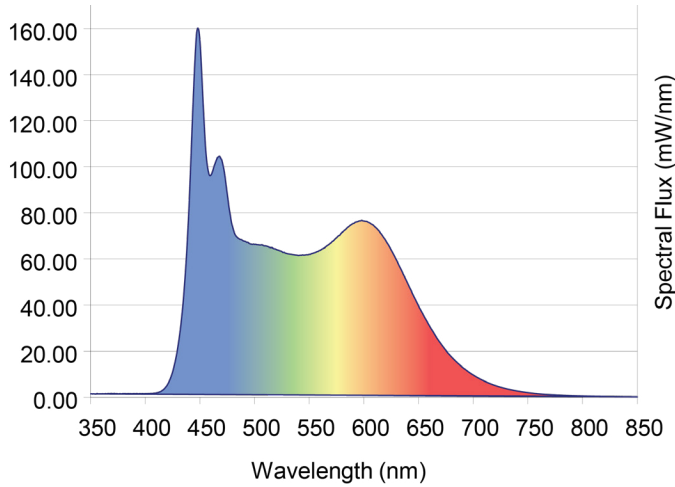

DAY MODE

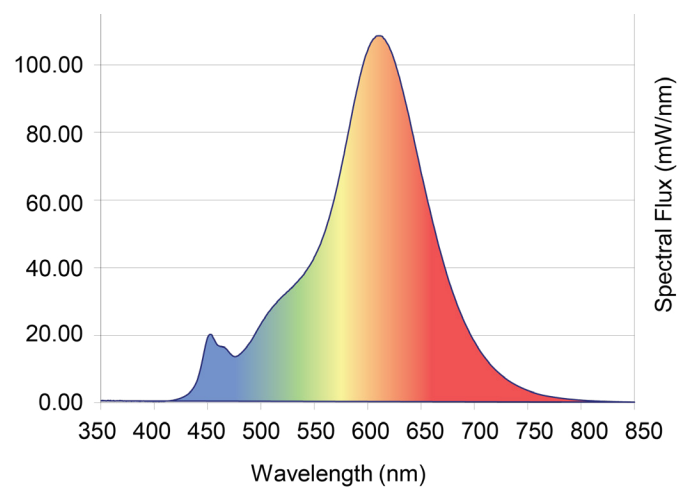

EVENING MODE

PERFORMANCE CHARTS

DAY MODE White (WHT) Finish

Type	Lumens	Wattage	MP Ratio	MDER	Efficacy
3000 WHT	3790	31W	1.2	1.1	118 lm/W
4000 WHT	4858	42W	1.2	1.1	114 lm/W
5000 WHT	6095	55W	1.2	1.1	111 lm/W

DAY MODE Black (BLK) Finish

Type	Lumens	Wattage	MP Ratio	MDER	Efficacy
3000 BLK	3180	31W	1.1	1.0	102 lm/W
4000 BLK	4212	42W	1.1	1.0	98 lm/W
5000 BLK	5084	55W	1.1	1.0	93 lm/W

EVENING MODE White (WHT) Finish

Type	Lumens	Wattage	MP Ratio	MDER	Efficacy
3000 WHT	3401	36W	0.38	0.33	94 lm/W
4000 WHT	4244	46W	0.38	0.33	92 lm/W
5000 WHT	5081	57W	0.38	0.33	89 lm/W

EVENING MODE Black (BLK) Finish

Type	Lumens	Wattage	MP Ratio	MDER	Efficacy
3000 BLK	2856	36W	0.35	0.30	80 lm/W
4000 BLK	3565	46W	0.35	0.30	78 lm/W
5000 BLK	4267	57W	0.35	0.30	75 lm/W

DIMENSIONS

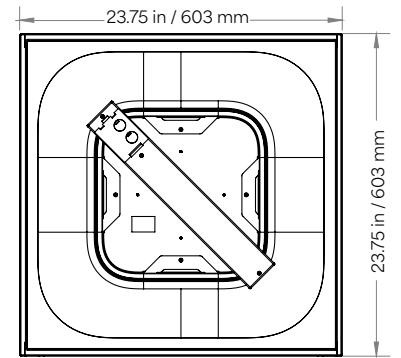
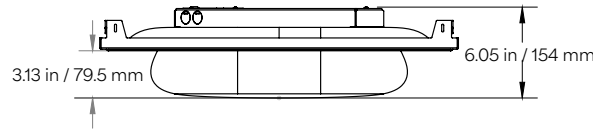
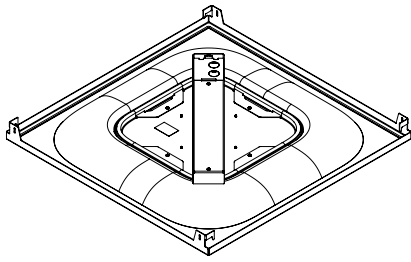

TYPICAL LIGHTING LAYOUT

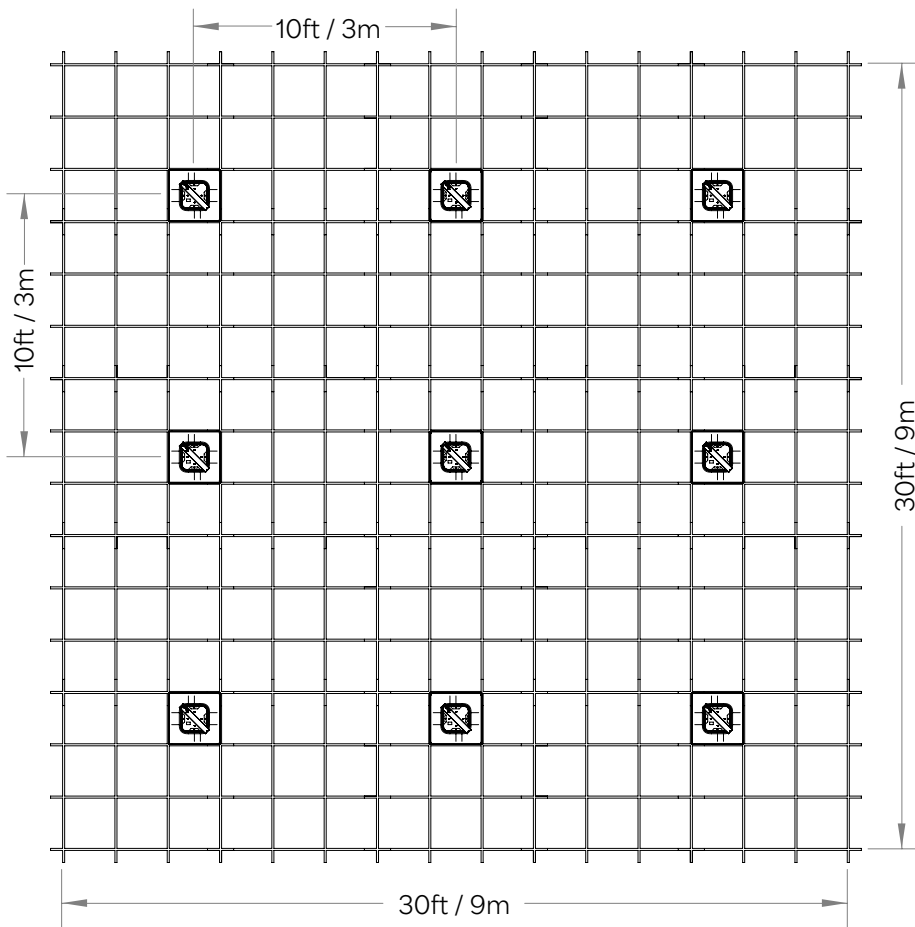

Example placement of a 4000 lm fixture layout in a 30ft x 30ft / 9.14m x 9.14m room with a 10ft / 3.05m ceiling height, achieving 35 FC / 300 lux task plane luminance and 250 melanopic equivalent daylight illuminance (m-EDI).

LIFETIME EXPECTANCY

LM-80 Data	
L70	> 60000 hours
L80	> 60000 hours
L90	> 60000 hours

UGR

Lumen Package	UGR
3000	16 WHT
3000	15 BLK
4000	17 WHT
4000	16 BLK
5000	18 WHT
5000	17 BLK

SUGGESTED SPACING GRID

Grid Spacing	Lumen Output	Horizontal FC	Vertical m-EDI	Ceiling Height	LPD
10ft x 10ft	4000	35	250	8.5ft - 10ft	0.40 W/ft ²
8ft x 8ft	3000	35	250	8ft	0.44 W/ft ²
12ft x 12ft	5000	35	250	10ft - 11ft	0.43 W/ft ²

CONTROLS

0-10V WITH BIO-DIMMING™ MODULE

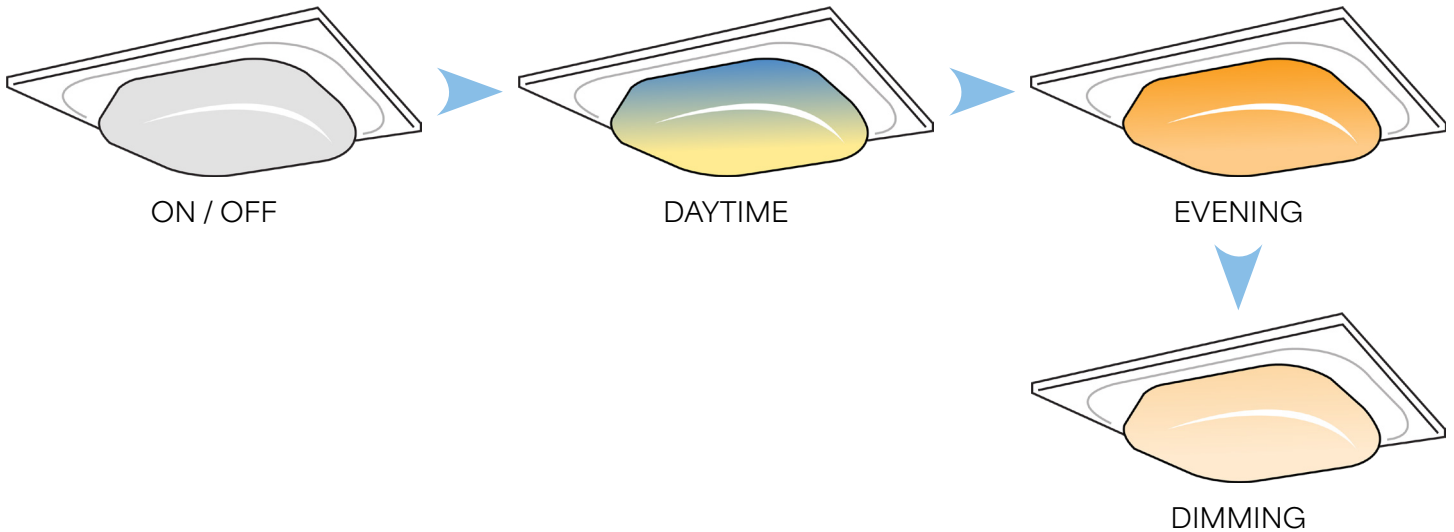

The BIOS Bio-Dimming™ Module enables both spectrum and intensity control using a standard single-channel dimming circuit—no need for complex multi-channel systems. The bio-dimmer option uses a 0-10V driver to turn out fixtures on/off or change between our daytime and evening modes, similar to a dim-to-glow fixture. Intensity can only be adjusted on the evening mode with the bio-dimmer driver.

DALI 2 DT8 CONTROLS

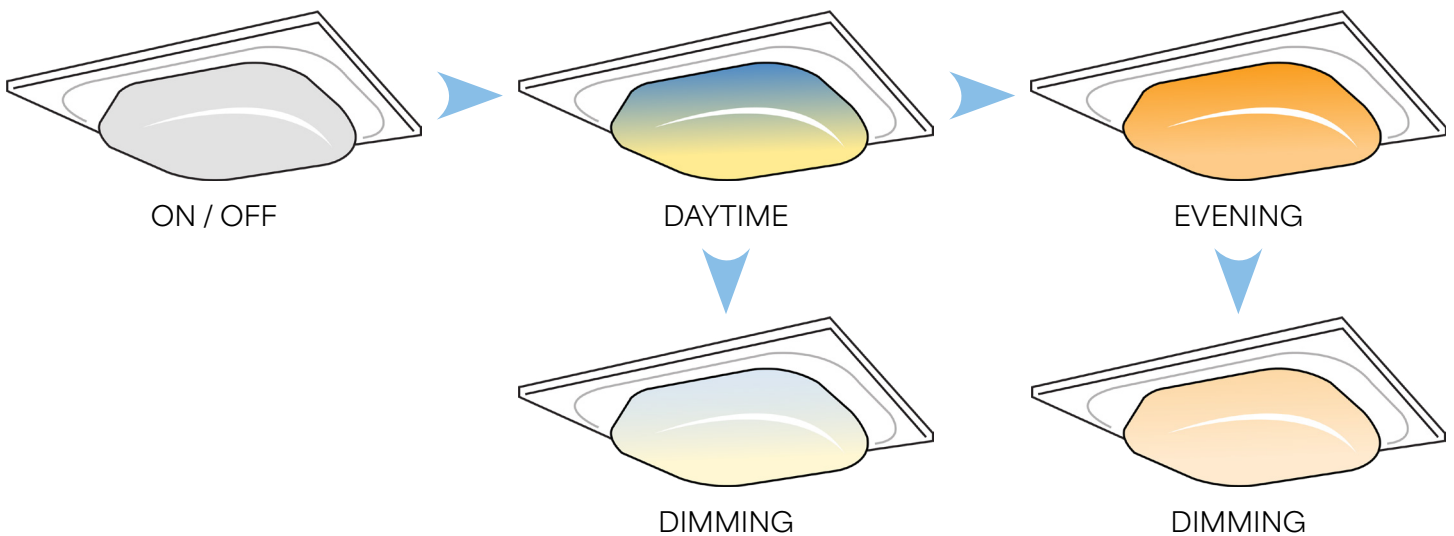

Our DALI 2 solution uses a DT8 driver. This allows the fixture to use a single DALI 2 address to change from daytime to evening mode as well as dimming for both modes.

WIRING DIAGRAMS

0-10V WITH BIO-DIMMER

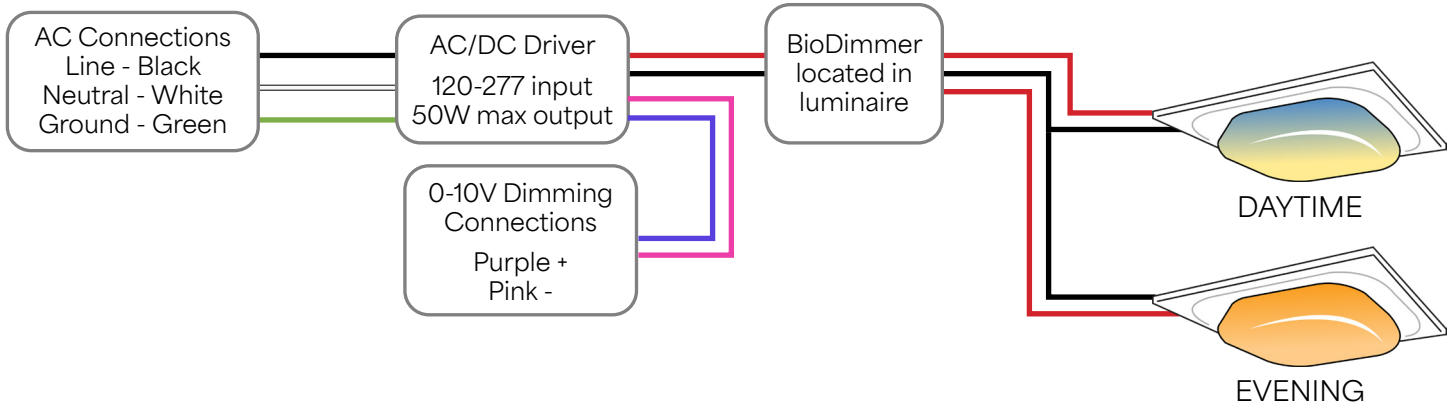

DALI 2 DT8

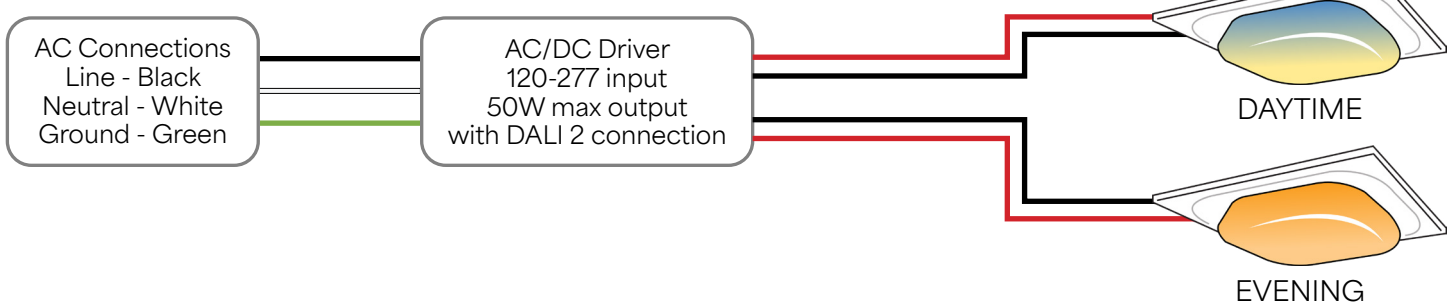

TECHNICAL SPECIFICATIONS

CONSTRUCTION

- Formed 24 ga. steel housing
- Universal T-bar clips, seismic restraint tabs/tie-offs

OPTICAL

- Patented SkyView™ Blue Sky Gradient™ Technology light engine
- Precision molded high transmittance LLDPE plastic diffuser that is recyclable
- Long-life LED system designed for typical TM21 lumen maintenance \geq L90 @ 60000 hours
- Available in 3000, 4000 and 5000 lumen packages with CRI \geq 90 and R9 \geq 80
- CCT range is 15000K to 4000K with a delivered CCT of 5300K

ELECTRICAL

- Driver Lifetime: 50000 hours
- Power Factor > 0.95
- Total Harmonic Distortion < 20%
- Dim level: Standard Day/Evening 100-0.01%
- Surge Protection: Meets ANSI C82.11 spec and ANSI/IEEE C62.41
- Inrush Current: Meets NEMA 410

CONTROLS

- SkyView™ fixtures use standard building control protocols, like 0-10V and DALI 2. Because SkyView™ products do not dynamically change CCT throughout the day like many tunable white or circadian fixtures on the market, simple room-level controls can be used. Wall box dimmers, distributed solutions, like power packs or even panel-based solutions can all control SkyView™ products.
- SkyView™ Tile from BIOS Lighting supports integrated occupancy sensing and daylight harvesting controls to improve energy performances without compromising circadian lighting outcomes.

DALI DRIVER

- DALI 2 DT8 means that one DALI address controls intensity and day/evening

ENVIRONMENT

- Designed for use in dry or damp indoor locations with ambient temperatures of 0-30° C or 32-86° F
- IP22 Rating
- Not suitable for natatorium environments

WEIGHT

- Maximum 10 lbs (4.54 kg) with standard driver

WARRANTY

- 5-year limited warranty on all components and workmanship

INDEPENDENT TESTING

- IESNA LM79
- IESNA LM80 (LED @ 10000 hours)

APPROVALS

- UL Listed (USA + Canada)
- RoHS Certificate of Conformity
- Declare Red List Approved